

Betty 170x80

**PREDINSTALACIJA
PREDINSTALLACIJA
PREINSTALLATION
VORINSTALLATION**

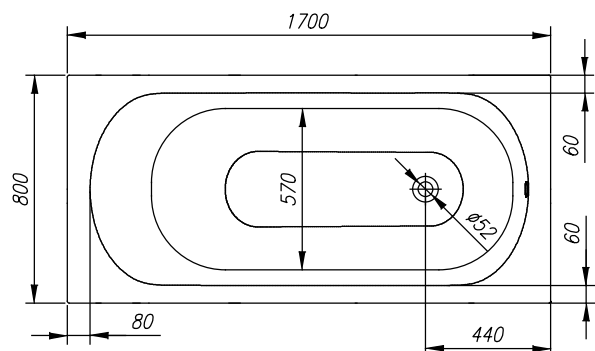
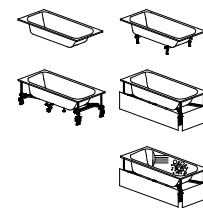
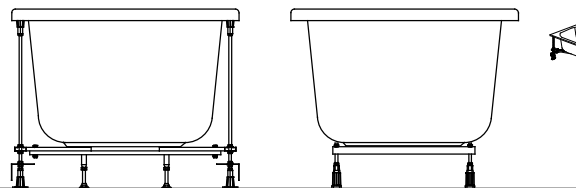
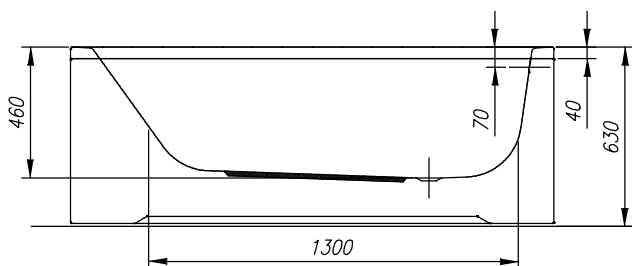

245 L

**VOLUMEN
VOLUMEN
VOLUME
VOLUMEN**

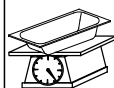

24 kg

**TEŽA
TEŽINA
WEIGHT
GEWICHT**

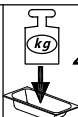

440 kg

**MAX. OBREMENITEV
MAX. OBTEREČENJE
MAX. LOAD
MAX. BELASTUNG**

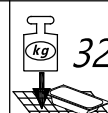

325 kg/m²

**OBREMENITEV TAL
OBTEREČENJE PODA
FLOOR LOAD
BODENBELASTUNG**



- Prostor za električni vodnik 3x2,5 mm², dolžine pribl. 1 m
- Mjesto za električni vodnik 3x2,5 mm², dužine cca. 1 m
- Spot for electrical cable 3x2,5 mm², length approx. 1 m
- Platz Stromkabel 3x2,5 mm², Länge ungefähr 1 m



- Prostor za električni vodnik 1x6 mm² za ozemljitev, dolžine pribl. 1,5 m
- Mjesto za električni vodnik 1x6 mm² za ozemljenje, dužine cca. 1,5 m
- Spot for electrical cable 1x6 mm² for earthing, length approx. 1,5 m
- Platz Stromkabel 1x6 mm² für Erdung, Länge ungefähr 1,5 m



- Priklop tople in hladne vode 1/2", min 0,2 Mpa, max 0,4 Mpa
- Priključak tople i hladne vode 1/2", min 0,2 Mpa, max 0,4 Mpa
- Connection of hot and cold water 1/2", min 0,2Mpa, max 0,4Mpa
- Anschluss Warm- und Kaltwasser 1/2", min 0,2 Mpa, max 0,4 Mpa



- Prostor za odtok Ø 50 mm
- Mjesto za odtok Ø 50 mm
- Drain spot Ø 50mm
- Abflussplatz Ø 50 mm



- Opcija-obloga
- Opcija-obloga
- Panel - option
- Möglichkeit - Schürze

*priporočilo za vgradnjo
preporuka za ugradnju
installation recommendation
Einbauempfehlung*

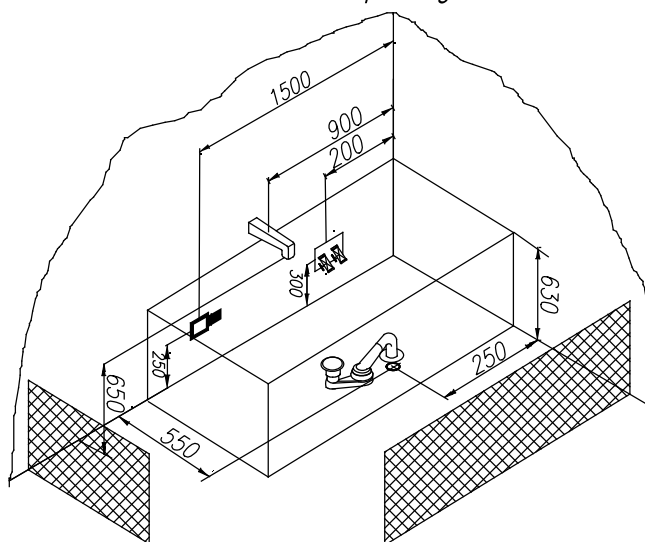

*Priporočena prelivna garnitura
Preporuka prelivne garniture
Recommended overflow set
Vorgeschlagene Überlaufgarnitur*

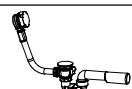

PAL 650

*kopalna kad brez oblog - navodilo za vgradnjo
Kada bez obloge - upute za ugradnju
Bathtub without panel - installation instructions
Badewanne ohne Schürze - Einbauanleitung*

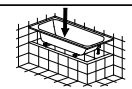

Nr. MK 03

*Opcija podnožja za kadi brez obloge
Varianta postolja za kade bez obloge
Option of the built-in bathtub base
Möglichkeit des Sockels für die Badewannen ohne Schürze*

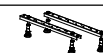

*Nr. MK 05
PKK 501*

*Kopalna kad z oblogo - navodilo za vgradnjo
Kada s oblogom - upute za ugradnju
Bathtub with panel - installation instructions
Badewanne mit Schürze - Einbauanleitung*

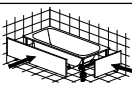

Nr. MK 01

*Opcija podnožja za kadi z oblogo
Varianta postolja za kade sa oblogom
Option of the bathtub base with panel
Möglichkeit des Sockels für die Badewannen mit Schürze*



*Nr. MK 12
CM 160-170*



- OPCIJA ENOROČNA ARMATURA GEYSER
- OPCIJA JEDNORUČNA ARMATURA GEYSER
- OPTION ONE HAND FITTING GEYSER
- MÖGLICHKEIT EINWEG-ARMATUR GEYSER

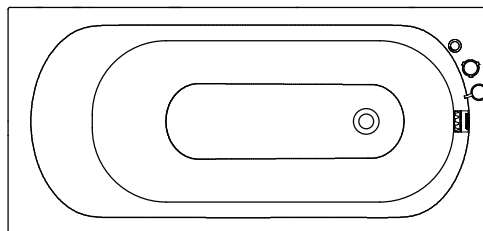
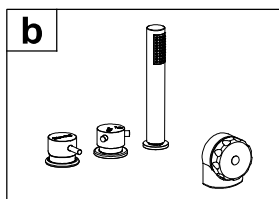

- OPCIJA ENOROČNA ARMATURA RAINDROP
- OPCIJA JEDNORUČNA ARMATURA RAINDROP
- OPTION ONE HAND FITTING RAINDROP
- MÖGLICHKEIT EINWEG-ARMATUR RAINDROP

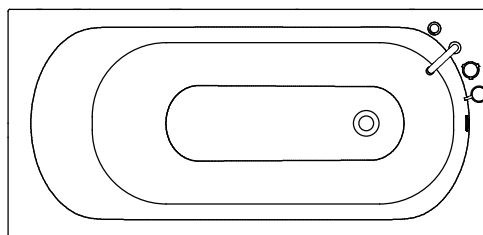
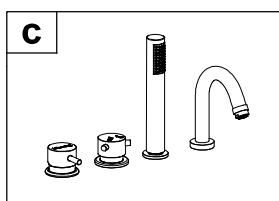

- OPCIJA ENOROČNA ARMATURA STREAM (CHR / BLACK)
- OPCIJA JEDNORUČNA ARMATURA STREAM (CHR / BLACK)
- OPTION ONE HAND FITTING STREAM (CHR / BLACK)
- MÖGLICHKEIT EINWEG-ARMATUR STREAM (CHR / BLACK)

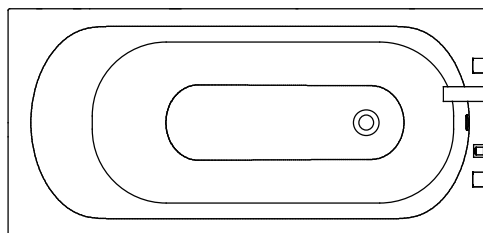
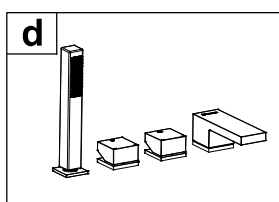

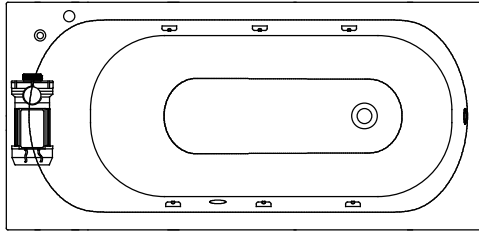
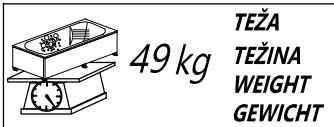
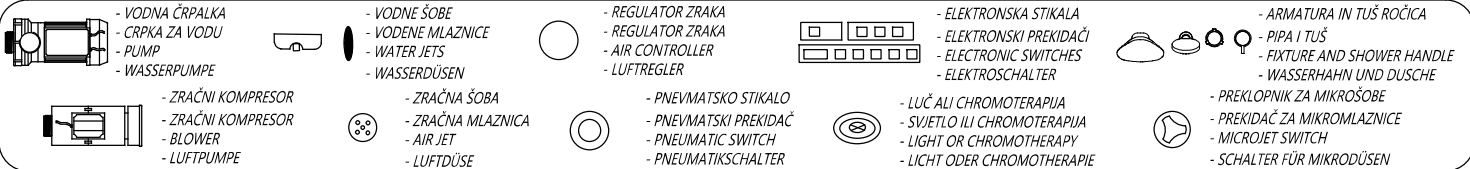

VODNI MASAŽNI SISTEM 1

- VODNA ČRPALKA P= 800W
- PNEVMATSKO STIKALO
- REGULATOR ZRAKA
- 6 VODNIH ŠOB

VODENI MASAŽNI SISTEM 1

- CRPKA ZA VODU P= 800W
- PNEVMATSKI PREKIDAČ
- REGULATOR ZRAKA
- 6 MLAZNICA ZA VODU

WATER MASSAGE SYSTEM 1

- PUMP P=800W
- PNEUMATIC SWITCH
- AIR CONTROLLER
- 6 WATER JETS

WASSERMASSEGESYSTEM 1

- WASSERPUMPE P = 800 W
- PNEUMATIKSCHALTER
- LUFTREGLER
- 6 WASSERDÜSEN

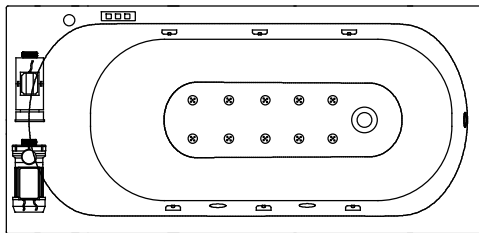
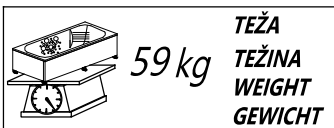

**VODNI IN ZRAČNI
 MASAŽNI SISTEM**

- VODNA ČRPALKA P= 800W
- ZRAČNI KOMPRESOR P=800W
- ELEKTRONSKO STIKALO
- 6 SUPER VODNIH ŠOB
- 10 ZRAČNIH ŠOB
- REGULATOR ZRAKA

**VODENI I ZRAČNI
 MASAŽNI SISTEM**







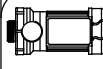

- CRPKA ZA VODU P= 800W
- ZRAČNI KOMPRESOR P=800W
- ELEKTRONSKI PREKIDAČ
- 6 SUPER MLAZNICA ZA VODU
- 10 ZRAČNIH MLAZNICA
- REGULATOR ZRAKA

**WATER AND AIR
 MASSAGE SYSTEM**

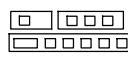
- PUMP P=800W
- BLOWER P=800W
- ELECTRONIC SWITCH
- 6 SUPER WATER JETS
- 10 AIR JETS
- AIR REGULATOR

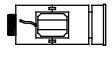
**WASSER UND LUFT
 MASSAGESYSTEM**

- WASSERPUMPE P = 800 W
- LUFTPUMPE P = 800 W
- ELEKTROSCHALTER
- 6 SUPER-WASSERDÜSEN
- 10 LUFTDÜSEN
- LUFTREGLER

 - VODNA ČRPALKA - CRPKA ZA VODU - PUMP - WASSERPUMPE	 - VODNE ŠOBE - VODNE MLAZNICE - WATER JETS - WASSERDÜSEN	 - REGULATOR ZRAKA - REGULATOR ZRAKA - AIR CONTROLLER - LUFTREGLER	 - ELEKTRONSKA STIKALA - ELEKTRONSKI PREKIDAČI - ELECTRONIC SWITCHES - ELEKTROSCHALTER	 - ARMATURA IN TUŠ ROČICA - PIPA I TUŠ - FIXTURE AND SHOWER HANDLE - WASSERHAHN UND DUSCHE
 - ZRAČNI KOMPRESOR - ZRAČNI KOMPRESOR - BLOWER - LUFTPUMPE	 - ZRAČNA ŠOBA - ZRAČNA MLAZNICA - AIR JET - LUFTDÜSE	 - PNEVMATSKO STIKALO - PNEVMATSKI PREKIDAČ - PNEUMATIC SWITCH - PNEUMATIKSCHALTER	 - LUČ ALI CHROMOTERAPIJA - SVJETLO ILI CHROMOTERAPIJA - LIGHT OR CHROMOTHERAPY - LICHT ODER CHROMOTHERAPIE	 - PREKLOPNIK ZA MIKROŠOBE - PREKIDAČ ZA MIKROMLAZNICE - MICROJET SWITCH - SCHALTER FÜR MIKRODÜSEN

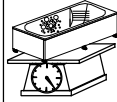

TEŽA
TEŽINA
WEIGHT
GEWICHT

70 kg

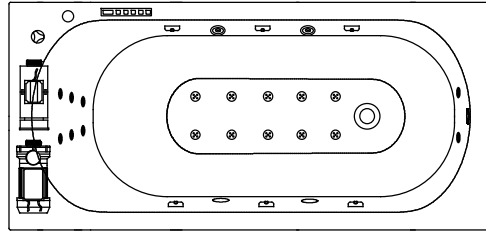

VITAL MASAŽNI SISTEM

- VODNA ČRPALKA P=1250W
- ZRAČNI KOMPRESOR P=800W
- GRELEC P=1500W
- ELEKTRONSKO STIKALO
- REGULATOR ZRAKA
- 6 SUPER VODNIH ŠOB
- 10 ZRAČNIH ŠOB
- OZON ZA DEZINFEKCIJU
- CHROMOTERAPIJA
- 6 MIKROŠOB ZA HRBET
- 2 MIKROŠOBI ZA NOGE

VITAL MASAŽNI SISTEM

- CRPKA ZA VODU P=1250W
- ZRAČNI KOMPRESOR P=800W
- GRUJAČ P=1500W
- ELEKTRONSKI PREKIDAČ
- REGULATOR ZRAKA
- 6 SUPER VODNIH MLAZNICA
- 10 ZRAČNIH MLAZNICA
- OZON ZA DEZINFEKCIJU
- CHROMOTERAPIJA
- 6 MIKROMLAZNICA ZA LEDA
- 2 MIKROMLAZNICE ZA NOGE

VITAL MASSAGE SYSTEM

- PUMP P=1250W
- BLOWER P=800W
- HEATER P=1500W
- ELECTRONIC SWITCH
- AIR CONTROLLER
- 6 SUPER WATER JETS
- 10 AIR JETS
- OZONE FOR DISINFECTION
- CHROMOTHERAPY
- 6 MICROJETS FOR BACK
- 2 MICROJETS FOR FEET

VITAL MASSAGESYSTEM

- WASSERPUMPE P = 1250 W
- LUFTPUMPE P = 800 W
- HEIZKÖRPER P = 1500 W
- ELEKTROSCHALTER
- LUFTREGLER
- 6 SUPER WASSERDÜSEN
- 10 LUFTDÜSEN
- OZON FÜR DESINFEKTION
- CHROMOTHERAPIE
- 6 MIKRODÜSEN FÜR RÜCKEN
- 2 MIKRODÜSEN FÜR FÜSSE

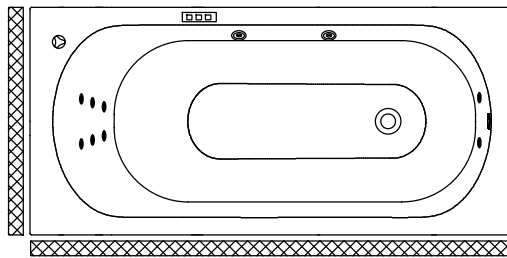

OPCIJE

- OPCIJA MIKROŠOBE 6 P=1250W

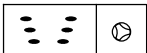

- OPCIJA DVE DODATNI MIKRO ŠOBI

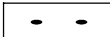

- OPCIJA CHROMOTERAPIJA



- POLOŽAJ OBLOG NA KOPALNI KADI

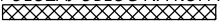

OPCIJE

- OPCIJA MIKROMLAZNICE 6 P=1250W

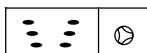

- OPCIJA DVIJE DODATNE MIKROMLAZNICE

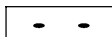

- OPCIJA CHROMOTERAPIJA

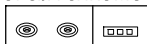

- POZICIJA OBLOGE NA KADI



OPTIONS

- OPTION 6 MICROJETS P=1250W



- OPTION TWO ADDITIONAL MICROJETS

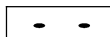

- OPTION CHROMOTHERAPY



- PANEL POSITIONS ON THE BATH



MÖGLICHKEITEN

- MÖGLICHKEIT MIKRODÜSEN 6 P = 1250 W

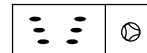

- MÖGLICHKEIT ZWEI ZUSÄTZLICHE MIKRODÜSEN

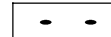

- MÖGLICHKEIT CHROMOTHERAPIE



- POSITION DER SHÜRZE FÜR BADEWANNE

